

Uniqueness of DP -Nash Subgraphs and D -sets in Weighted Graphs of Netflix Games

Gregory Gutin¹, Philip R. Neary², and Anders Yeo^{3,4}

¹ Department of Computer Science, Royal Holloway, University of London, Egham,
United Kingdom g.gutin@rhul.ac.uk

² Department of Economics, Royal Holloway, University of London, Egham, United
Kingdom philip.neary@rhul.ac.uk

³ Department of Mathematics and Computer Science, University of Southern
Denmark, Denmark andersyeo@gmail.com

⁴ Department of Pure and Applied Mathematics, University of Johannesburg, South
Africa

Abstract. Gerke et al. (arXiv:1905.01693, 2019) introduced Netflix Games and proved that every such game has a pure strategy Nash equilibrium. In this paper, we explore the uniqueness of pure strategy Nash equilibria in Netflix Games. Let $G = (V, E)$ be a graph and $\kappa : V \rightarrow \mathbb{Z}_{\geq 0}$ a function, and call the pair (G, κ) a *weighted graph*. A spanning subgraph H of (G, κ) is called a *DP-Nash subgraph* if H is bipartite with partite sets D, P called the *D-set* and *P-set* of H , respectively, such that no vertex of P is isolated and for every $x \in D$, $d_H(x) = \min\{d_G(x), \kappa(x)\}$. We prove that whether (G, κ) has a unique DP-Nash subgraph can be decided in polynomial time. We also show that when $\kappa(v) = k \in \mathbb{Z}_{\geq 0}$ for every $v \in V$, the problem of deciding whether (G, κ) has a unique D -set is polynomial time solvable for $k = 0$ and 1 , and co-NP-complete for $k \geq 2$.

1 Introduction

In this paper, all graphs are undirected, finite, without loops or parallel edges. Let $G = (V, E)$ be a graph and $\kappa : V \rightarrow \mathbb{Z}_{\geq 0}$ a function. For $v \in V$, we will call $\kappa(v)$ the *weight* of v and the pair (G, κ) a *weighted graph*. A spanning subgraph H of (G, κ) is called a *DP-Nash subgraph* if H is bipartite with partite sets D and P called the *D-set* and *P-set* of H , respectively, such that no vertex of P is isolated and for every $x \in D$, $d_H(x) = \min\{d_G(x), \kappa(x)\}$, where $d_H(x)$ and $d_G(x)$ are the degrees of x in H and G , respectively. Since H is a bipartite graph, we will write it as the triple $(D, P; E')$, where D, P are D -set and P -set of H , respectively, and E' is the edge set of H . A vertex set B is a *D-set* of (G, κ) if (G, κ) has a DP-Nash subgraph in which B is the D -set. Gerke et al. [6] proved the following:

Theorem 1. *Every weighted graph (G, κ) has a DP-Nash subgraph.*

Theorem 1 implies that every weighted graph has a D -set. We provide a proof of the theorem in Appendix A to make this paper self-contained.

Let us consider a few examples of DP -Nash subgraphs and D -sets. If $\kappa(x) = 0$ for every $x \in V$ then there is only one DP -Nash subgraph with D -set V and empty P -set. If $\kappa(x) = 1$ for every $x \in V$ then every DP -Nash subgraph is a spanning vertex-disjoint collection of stars, each with at least two vertices. If $\kappa(x) = d_G(x)$ for every $x \in V$ then the D -set of each DP -Nash subgraph of (G, κ) is a maximal independent set of G . It is well-known that a vertex set is maximal independent if and only if it is independent dominating. Since finding both maximum size independent set and minimum size independent dominating set are both NP-hard [2], so are the problems of finding a D -set of maximum and minimum size. For more information on complexity of independent domination, see [7].

The notion of a D -set is not directly related to the CAPACITATED DOMINATION problem where the number of vertices which a vertex can dominate does not exceed its weight (capacity) [3, 9]. D -sets provide what one can call *exact* capacitated domination, not studied in the literature yet, as far as we know.

Theorem 1 means that all Netflix Games introduced in [6] have pure strategy Nash equilibria; see Section 2 for a brief discussion of Netflix Games and their relation to DP -Nash subgraphs and D -sets in weighted graphs. As explained in Section 2, there are two natural problems of interest in economics.

DP-NASH SUBGRAPH UNIQUENESS: decide whether a weighted graph has a unique DP-Nash subgraph, and

D-SET UNIQUENESS: decide whether a weighted graph has a unique D-set.

While the problems are clearly related, we show that their time complexities are not unless $P=co-NP$: DP -NASH SUBGRAPH UNIQUENESS is polynomial-time solvable and D -SET UNIQUENESS is co-NP-complete. In fact, for D -SET UNIQUENESS we prove the following complexity dichotomy when $\kappa(x) = k$ for every vertex $x \in V$, where k is a non-negative integer. If $k \geq 2$ then D -SET UNIQUENESS is co-NP-complete and if $k \in \{0, 1\}$ then D -SET UNIQUENESS is in P. We note that the proof of Theorem 1 in Appendix A implies that constructing a DP -Nash subgraph and, thus, a D -set in every weighted graph is polynomial-time solvable.

Preliminaries are given in Section 3. To obtain the above polynomial-time complexity results for DP -NASH SUBGRAPH UNIQUENESS and D -SET UNIQUENESS, we first prove in Section 4 a characterization of weighted graphs with unique D -sets, which we believe is of interest in its own right. In Section 5, we show that DP -NASH SUBGRAPH UNIQUENESS is in P. In Section 6 we prove the above-mentioned complexity dichotomy for D -SET UNIQUENESS.¹ We conclude the paper in Section 7.

¹ It is somewhat interesting that despite the characterization for D -SET UNIQUENESS, the problem is co-NP-complete.

2 Motivation

There are many economic situations that are collectively referred to as *combinatorial assignment problems*. The first systematic approach to issues of this type was by Gale and Shapley [4] who studied ‘matching’ in marriage markets. They imagined a group of n women and another group of n men, where everyone wants to be matched with one member of the opposite sex. The problem of finding an assignment that leaves everyone ‘content’ is difficult since there are $n!$ possible assignments and individuals have preferences. Gale and Shapley proposed a solution. They called an assignment between women and men *stable* if there does not exist a woman-man pair (call them Ann and Barry) such that: 1) Ann is not paired with Barry, 2) Ann prefers Barry to her match, and 3) Barry prefers Ann to his match. Gale and Shapley’s ‘deferred acceptance algorithm’ confirms that a stable match always exists. Variants and extensions of the algorithm have been applied to a wide variety of assignment problems in economics including college admissions, the market for kidney donors, and refugee resettlement (see [14] for a survey).²

The assignment problem that motivates our study arises in the provision of local public goods. The story is as follows. There is a society of individuals arranged in a social network modelled as a graph where vertices represent individuals and edges capture friendships. There is a desirable product, say access to Netflix or Microsoft Office, that is available for purchase. While the product can be shared upon purchase, an owner may only share access with a limited number of friends. Individual preferences are such that it is always better to have access than not, but, since access is costly each individual prefers that a friend purchases and shares their access than vice versa. This describes the Netflix Games of Gerke et al. [6].³ For a given Netflix game, a D -set lists those who purchase the product in equilibrium, while a DP -Nash subgraph lists those who purchase (the D -set), those who free-ride (the P -set), and exactly who in D each individual in P receives an offer of access from (the edge set).⁴ Netflix Games generalise the models of local public goods without weight constraints, see [1, 5], for which the stable outcomes correspond to maximal independent sets.

The rationale for a detailed focus on what weighted graphs (G, κ) admit a unique DP -Nash subgraph and/or a unique D -set is that economic models with

² Lloyd Shapley and Alvin Roth received the 2012 Nobel Memorial Prize in Economics for their work in this area. (David Gale died in 2007.)

³ Vertices being constrained in the number of neighbours they may share with seems well-suited to applications. In Netflix Games sharing bestows a benefit on neighbours, but this need not be the case. Gutin et al. [8] add constrained sharing to the Susceptible-Infected-Removed (SIR) model of disease transmission of Kermack and McKendrick [10]. Gutin et al. interpret constrained sharing as ‘social distancing’ restrictions imposed on a population and document how the reach of an epidemic is curtailed when such measures are in place.

⁴ One example from Gerke et al. was of a group of individuals who each want to attend an event and can ride-share to get to it. Every individual will be assigned as either a Driver or a Passenger, hence the labels D and P .

a unique equilibrium are as rare as they are useful. Uniqueness is rare due to the mathematical structure of economic models (formally, the best-response map of Nash [12, 13] rarely admits only one fixed point). Uniqueness is useful as (i) it saves the analyst from an ‘equilibrium selection’ headache - justifying why one equilibrium is more likely to emerge than another, and (ii) allows those who study *game-design* to be confident in generating a particular outcome (since only one outcome is stable). It is for this reason that models with unique equilibria are so highly coveted (see for example the model of currency attacks in [11]), and why we believe the study of conditions under which unique *DP*-Nash subgraphs and *D*-sets exist will be of great interest to the economics community.

3 Preliminaries

In the rest of the paper, we will often write G instead of (G, κ) when the weight function κ is clear from the context. We will often omit the subscript G in $N_G(x)$ and $d_G(x)$ when the graph G under consideration is clear from the context. We will often shorten the term *DP*-Nash subgraph to Nash subgraph.

In the rest of this section, we provide two simple assumptions for the rest of the paper which will allow us to simplify some of our proofs. In both assumptions, (G, κ) is a weighted graph.

Assumption 1: *For all $u \in V$ we have $\kappa(u) \leq d(u)$.*

Assumption 1 does not change the set of *DP*-Nash subgraphs of any weighted graph as if $\kappa(u) > d(u)$ we may let $\kappa(u) = d(u)$ without changing $\min\{\kappa(u), d(u)\}$. Due to this assumption, we can simplify the definition of a *DP*-Nash subgraph of a weighted graph (G, κ) . A spanning subgraph H of G is called a *DP-Nash subgraph* if H is bipartite with partite sets D, P called the *D-set* and *P-set* of H , respectively, such that no vertex of P is isolated and for every $x \in D$, $d_H(x) = \kappa(x)$. Note that Assumption 1 may not hold for a subgraph of (G, κ) if the subgraph uses the same weight function κ restricted to its vertices.

Assumption 2: *If uv is an edge in G , then $\kappa(u) > 0$ or $\kappa(v) > 0$.*

This assumption does not change our problem due to the following:

Proposition 1. *Let G^* be obtained from G by deleting all edges uv with $\kappa(u) = \kappa(v) = 0$. Then $(D, P; E')$ is a Nash subgraph of (G, κ) if and only if $(D, P; E')$ is a Nash subgraph of (G^*, κ) .*

Proof. Let uv be any edge in G with $\kappa(u) = \kappa(v) = 0$ and let $(D, P; E')$ be a Nash subgraph of (G, κ) . Note that $uv \notin E'$ as if $u \in D$ then E' contains no edge incident with u and if $v \in D$ then E' contains no edge incident with v and if $u, v \in P$ then E' does not contain the edge uv . This implies $(D, P; E')$ is a Nash subgraph of (G^*, κ) .

Conversely if $(D, P; E')$ is a Nash subgraph of (G^*, κ) then $(D, P; E')$ is a Nash subgraph of (G, κ) as both graphs have the same weight function and G^* is a spanning subgraph of G . \square

4 Characterisation of Weighted Graphs with Unique D-set

We begin this section by introducing some definitions and additional notation. For a set F of edges of a graph H and a vertex x of H , $N_F(x) = \{y \in V(H) | xy \in F\}$ and $d_F(x) = |N_F(x)|$. For a vertex set Q of a graph H , $N_H(Q) = \bigcup_{x \in Q} N_H(x)$. Define $X(G, \kappa)$, $Y(G, \kappa)$ and $Z(G, \kappa)$ as follows. If (G, κ) is clear from the context these sets will be denoted by X , Y and Z , respectively.

$$\begin{aligned} X &= X(G, \kappa) := \{x \mid \kappa(x) = d(x)\} \\ Y &= Y(G, \kappa) := N(X) \setminus X \\ Z &= Z(G, \kappa) := V(G) \setminus (X \cup Y) \end{aligned}$$

Lemma 1. *Let $u \in V(G)$ and let $X = X(G, \kappa)$. If $|N_G(u) \cap X| \leq \kappa(u)$ then there exists a Nash subgraph $(D, P; E)$ of (G, κ) where $u \in D$ and $N_G(u) \cap X \subseteq P$. Furthermore, if $|N_G(u) \cap X| < \kappa(u)$ and $w \in N_G(u) \setminus X$ then there exists a Nash subgraph $(D, P; E)$ of (G, κ) where $u \in D$ and $\{w\} \cup (N_G(u) \cap X) \subseteq P$.*

Proof. Let $u \in V(G)$ such that $|N_G(u) \cap X| \leq \kappa(u)$. Recall that by Assumption 1 we have $\kappa(v) \leq d_G(v)$ for all $v \in V(G)$. Let E^* denote an arbitrary set of $\kappa(u)$ edges incident with u , such that $N_G(u) \cap X \subseteq N_{E^*}(u)$. Let $T' = N_{E^*}(u)$, $G' = G \setminus (\{u\} \cup T')$ and $(P', D'; E')$ a Nash subgraph of G' , which exists by Theorem 1. Let $P = P' \cup T'$ and let $D = D' \cup \{u\}$.

Initially let $\hat{E} = E' \cup E^*$. Clearly every vertex in P has at least one edge into D . Now let $v \in D$ be arbitrary. If $d_{\hat{E}}(v) \neq \kappa(v)$ (recall that $\kappa(v) \leq d_G(v)$) then we observe that $v \in D'$ and

$$d_{\hat{E}}(v) = d_{E'}(v) = \min\{d_{G'}(v), \kappa(v)\} < \kappa(v).$$

Since v either has no edge to u or does not lie in X , observe that we can add $\kappa(v) - d_{G'}(v)$ edges to \hat{E} between v and T' resulting in $d_{\hat{E}}(v) = \kappa(v)$. After doing the above for every $x \in D$ we obtain a Nash subgraph $(D, P; \hat{E})$ of G with the desired properties. This completes our proof of the case $|N_G(u) \cap X| \leq \kappa(u)$. The same proof can be used for the case $|N_G(u) \cap X| < \kappa(u)$ if we choose E^* such that $w \in T'$. \square

Lemma 2. *If $X \cup Z$ is not an independent set in (G, κ) , then there exist DP-Nash subgraphs of G with different D-sets. If $X \cup Z$ is an independent set in G then there exists a DP-Nash subgraph $(D, P; E')$ of (G, κ) where $D = X \cup Z$ and $P = Y$.*

Proof. First assume that $X \cup Z$ is not independent in G and that uv is an edge where $u, v \in X \cup Z$. By the definition of Z we have that $u, v \in X$ or $u, v \in Z$.

First consider the case when $u, v \in X$. Note that $|N_G(u) \cap X| \leq d(u) = \kappa(u)$, which by Lemma 1 implies that there is a Nash subgraph $(D', P'; E')$ in G where $u \in D'$ and $v \in P'$. Analogously, we can obtain a Nash subgraph $(D'', P''; E'')$ in G where $v \in D''$ and $u \in P''$, which implies that there exist Nash subgraphs of G with different D-sets, as desired.

We now consider the case when $u, v \in Z$. As uv is an edge in G we may without loss of generality assume that $\kappa(v) \geq 1$ (by Assumption 2). As $|N_G(v) \cap X| = 0 < \kappa(v)$, Lemma 1 implies that there is a Nash subgraph $(D', P'; E')$ in G where $v \in D'$ and $u \in P'$. As $|N_G(u) \cap X| = 0 \leq \kappa(u)$, Lemma 1 implies that there is a Nash subgraph $(D'', P''; E'')$ in G where $u \in D''$. As there exist Nash subgraphs where $u \in P'$ and where $u \in D''$, we are done in this case.

Now let $X \cup Z$ be independent in G and let $P = Y$ and $D = X \cup Z$. Let E' contain all edges between X and Y as well as any $\kappa(z)$ edges from z to P for all $z \in Z$. As $Y = N(X) \setminus X$ we conclude that $(D, P; E')$ is a Nash subgraph of (G, κ) . \square

To state our characterisation result for weighted graphs possessing a unique D -set, we need some additional definitions and two properties.

Given a weight κ on a graph G , for any subset $U \subseteq V(G)$ let U^κ denote a set of vertices obtained from U by replacing each vertex, $u \in U$, by its $\kappa(u)$ copies. Note that if $\kappa(u) = 0$ then the vertex u is not in U^κ and $|U^\kappa| = \sum_{u \in U} \kappa(u)$.

Given a weighted graph (G, κ) , let G^{aux} be a bipartite graph with partite sets $R' = X \cup Z$ and $Y' = Y^\kappa$. For a vertex $y \in Y$, there is an edge from a copy of y to $r \in R'$ in G^{aux} if and only if there is an edge from y to r in G .

Let $Y^{\kappa>0} \subseteq Y$ consist of all vertices $y \in Y$ with $\kappa(y) > 0$. For every set $\emptyset \neq W \subseteq Y^{\kappa>0}$ let

$$L(W) = \{x \in X \cup Z \mid |N(x) \cap W| > d(x) - \kappa(x)\}.$$

We now define the properties $M^*(G, \kappa)$ and $O^*(G, \kappa)$:

$M^*(G, \kappa)$ holds if for every set $\emptyset \neq W \subseteq Y^{\kappa>0}$ there is no matching from $L(W)$ to W^κ of size $|L(W)|$ in G^{aux} .

$O^*(G, \kappa)$ holds if for every set $\emptyset \neq W \subseteq Y^{\kappa>0}$ we have $|L(W)| > |W^\kappa|$.

Theorem 2. *If $X \cup Z$ is not independent in G then (G, κ) has at least two different D -sets. If $X \cup Z$ is independent in G then the following three statements are equivalent:*

- (a) G has a unique D -set;
- (b) $M^*(G, \kappa)$ holds;
- (c) $O^*(G, \kappa)$ holds.

Proof. The case of $X \cup Z$ being not independent follows from Lemma 2. We will therefore assume that $X \cup Z$ is independent in G and prove the rest of the theorem by showing that (a) \Rightarrow (b) \Rightarrow (c) \Rightarrow (a). The following three claims complete the proof.

Claim A: (a) \Rightarrow (b).

Proof of Claim A: Suppose that (a) holds but (b) does not. As (b) is false, $M^*(G, \kappa)$ does not hold, which implies that there exists a $\emptyset \neq W \subseteq Y^{\kappa>0}$ such that there is a matching, M , from $L(W)$ to W^κ of size $|L(W)|$ in G^{aux} .

Let $D_1 = W$, $P_1 = L(W)$ and $G_2 = G - (P_1 \cup D_1)$. Let $(D_2, P_2; E'_2)$ be a DP -Nash subgraph of G_2 , which exists by Theorem 1. We will now prove the following six subclaims.

Subclaim A.1: For every $y \in Y$, we have $|N(y) \cap X| \geq \kappa(y) + 1$.

Proof of Subclaim A.1: Assume that Subclaim A.1 is false and there exists a vertex $y \in Y$ such that $|N(y) \cap X| \leq \kappa(y)$. By Lemma 1, there exists a Nash subgraph $(D', P'; E')$ in G where $y \in D'$. By Lemma 2, there exists a Nash subgraph $(D'', P''; E'')$ in G where $y \in P''$ (as $P'' = Y$). Therefore (a) is false, a contradiction. \diamond

Subclaim A.2: If $u \in D_1 = W$ then $N(u) \cap X \subseteq P_1$. Furthermore, $|N(u) \cap P_1| \geq \kappa(u) + 1$.

Proof of Subclaim A.2: Let $u \in D_1$ (and therefore $u \in W$) be arbitrary and let $r \in N(u) \cap X$ be arbitrary. We will show that $r \in P_1$, which will prove the first part of the claim. As $r \in X$ we have $d_G(r) = \kappa(r)$. This implies that $|N(r) \cap W| \geq 1 > 0 = d_G(r) - \kappa(r)$. Hence, $r \in L(W) = P_1$ as desired.

We now prove the second part of Subclaim A.2. Since $u \in Y$, Subclaim A.1 implies that $|N(u) \cap X| \geq \kappa(u) + 1$. As every vertex in $N(u) \cap X$ also belongs to P_1 , we have $|N(u) \cap P_1| \geq \kappa(u) + 1$. \diamond

Subclaim A.3: There exists a Nash subgraph $(D_1, P_1; E'_1)$ of $G[D_1 \cup P_1]$.

Proof of Subclaim A.3: P_1 and D_1 were defined earlier so we will now define E'_1 . Let all edges of the matching M belong to E'_1 . That is if $u'v \in M$ and $u' \in V(G^{\text{aux}})$ is a copy of $u \in V(G)$, then add the edge uv to E'_1 . We note that every vertex in P_1 is incident to exactly one of the edges added so far and every vertex $u \in D_1$ is incident to at most $\kappa(u)$ such edges. By Subclaim A.2 we can add further edges between P_1 and D_1 such that every vertex $u \in D_1$ is incident with exactly $\kappa(u)$ edges from E'_1 . \diamond

Subclaim A.4: Every $u \in (X \cup Z) \setminus L(W)$ has at least $\kappa(u)$ neighbours in $Y \setminus W$.

Proof of Subclaim A.4: As $u \notin L(W)$ we have that $|N_G(u) \cap W| \leq d(u) - \kappa(u)$. This implies that $|N_G(u) \setminus W| \geq \kappa(u)$. As $X \cup Z$ is independent this implies that u has at least $\kappa(u)$ neighbours in $Y \setminus W$, as desired. \diamond

Recall that $(D_2, P_2; E'_2)$ is a Nash subgraph of G_2 and by Subclaim A.3, $(D_1, P_1; E'_1)$ is a DP -Nash subgraph of $G[D_1 \cup P_1]$.

Subclaim A.5: There exists a Nash subgraph $(P_1 \cup P_2, D_1 \cup D_2, E'_1 \cup E'_2 \cup E^*)$ of G for some E^* .

Proof of Subclaim A.5: Let $P = P_1 \cup P_2$, $D = D_1 \cup D_2$ and $E' = E'_1 \cup E'_2$. Clearly every vertex in P is incident with an edge in E' .

First consider a vertex $u \in D_1$. By Subclaim A.2, u has at least $\kappa(u) + 1$ neighbours in P_1 in G . Therefore, by Subclaim A.3, u is incident with exactly $\kappa(u)$ edges of E'_1 and so also with $\kappa(u)$ edges of E' .

Now consider $u \in D_2$. Note that u is incident with $\min\{\kappa(u), d_{G_2}(u)\}$ edges of E'_2 . If $u \in X \cup Z \setminus L(W)$ then by Subclaim A.4, $\min\{\kappa(u), d_{G_2}(u)\} = \kappa(u)$ implying that u is incident with exactly $\kappa(u)$ edges of E' as desired. We may

therefore assume that $u \notin X \cup Z \setminus L(W)$, which implies that $u \in Y \setminus W$. By Subclaim A.1, u has at least $\kappa(u) + 1$ neighbours in X in G . Therefore, $d_{G_2}(u) + |N(u) \cap P_1| \geq \kappa(u) + 1$ (as every edge from u to X is counted in the sum on the left hand side of the inequality). Thus, if $\min\{\kappa(u), d_{G_2}(u)\} < \kappa(u)$, then we can add edges from u to P_1 to E' until u is incident with exactly $\kappa(u)$ edges of E' . Continuing the above process for all u and letting E^* be the added edges, we obtain the claimed result. \diamond

Subclaim A.6: Claim A holds.

Proof of Subclaim A.6: By Lemma 2 there exists a DP -Nash subgraph, (D, P, E') , with $D = X \cup Z$ and $P = Y$. By Subclaim A.5, there exists a DP -Nash subgraph of G where some vertices of Y belong to D , contradicting the fact that (a) holds. This completes the proof of Subclaim A.6, and therefore also of Claim A. \diamond

Claim B: (b) \Rightarrow (c).

Proof of Claim B: Suppose that (b) holds but (c) does not. As (c) does not hold there exists a $\emptyset \neq W \subseteq Y^{\kappa > 0}$ such that $|L(W)| \leq |W|$. Assume that W is chosen such that $|W|$ is minimum possible with this property. As (b) holds there is no matching between W^κ and $L(W)$ in G^{aux} saturating every vertex of $L(W)$. By Hall's Theorem, this implies that there exists a set $S \subseteq L(W)$ such that $|N_{G^{\text{aux}}}(S)| < |S|$. Note that $N_G(S) \subseteq W$ such that $N_{G^{\text{aux}}}(S)$ contains exactly the copies of $N_G(S)$. Note that $|N_G(S)| \leq |N_{G^{\text{aux}}}(S)| < |S|$ as $W \subseteq Y^{\kappa > 0}$. Let $W' = W \setminus N_G(S)$.

By definition we have

$$L(W') = \{x \in X \cup Z \mid |N_G(x) \cap W'| > d(x) - \kappa(x)\}.$$

We will now prove the following subclaim.

Subclaim B.1: $L(W') \subseteq L(W) \setminus S$.

Proof of Subclaim B.1: Let $u \in L(W')$ be arbitrary and note that $|N_G(u) \cap W'| \geq |N_G(u) \cap W'| > d(u) - \kappa(u)$. This implies that $u \in L(W)$.

We will now show that $u \notin S$. If $u \in S$, then $N(u) \subseteq N(S)$, so u has no neighbours in $W' = W \setminus N(S)$. Therefore, $|N_G(u) \cap W'| = 0$, and as we assumed that $d(v) \geq \kappa(v)$ for all $v \in V(G)$, the following holds

$$|N_G(u) \cap W'| = 0 \leq d(u) - \kappa(u).$$

Therefore, $u \notin L(W')$, a contradiction. This implies that $u \notin S$ and therefore $L(W') \subseteq L(W) \setminus S$. \diamond

By Subclaim B.1, we have that $|L(W')| \leq |L(W)| - |S| < |L(W)| - |N_G(S)| = |W'|$. This contradicts the minimality of $|W|$, and therefore completes the proof of Claim B.

Claim C: (c) \Rightarrow (a).

Proof of Claim C: Suppose that (c) holds but (a) does not. By Lemma 2 and the fact that (a) does not hold, there exists a Nash subgraph $(D, P; E')$ of G such that $D \neq X \cup Z$.

If $Y^{\kappa>0} \subseteq P$, then no vertex of $X \cup Z$ can belong to P as it would have no edge to D (as $X \cup Z$ is independent). Therefore, $X \cup Z \subseteq D$ in this case. Due to the definition of X (and Y) and the fact that $X \subseteq D$, we have that $Y \subseteq P$, which implies that $D = X \cup Z$ and $Y = P$, which is a contradiction to our assumption that $D \neq X \cup Z$.

So we may assume that $Y^{\kappa>0} \not\subseteq P$. This implies that $Y^{\kappa>0} \cap D \neq \emptyset$. Let $W = Y^{\kappa>0} \cap D$. We now prove the following subclaim.

Subclaim C.1: $L(W) \subseteq P$.

Proof of Subclaim C.1: Let $w \in L(W)$ be arbitrary. Hence, $|N_G(w) \cap W| > d(w) - \kappa(w)$. If $w \in D$, then w has at least $\kappa(w)$ neighbours in P in G . By the above it has at least $d(w) - \kappa(w) + 1$ neighbours in $W \subseteq D$, contradicting the fact that w has $d(w)$ neighbours. This implies that $w \notin D$. Therefore, $w \in P$ and as $w \in L(W)$ is arbitrary, we must have $L(W) \subseteq P$. \diamond

We now return to the proof of Claim C. Recall that $X \cup Z$ is independent and $L(W) \subseteq X \cup W$ and every vertex in P has at least one edge to D in E' . By Subclaim C.1, $L(W) \subseteq P$, which implies that there are at least $|L(W)|$ edges from $L(W)$ to W , as $W = Y^{\kappa>0} \cap D$. As there are at most $\theta = \sum_{w \in W} \kappa(w)$ edges from W to $L(W)$ we must have $|L(W)| \leq \theta = \sum_{w \in W} \kappa(w) = |W^\kappa|$.

The above is a contradiction to (c). This completes the proof of Claim C and therefore also of the theorem. \square

We immediately have the following:

Corollary 1. *All Nash subgraphs of (G, κ) have the same D -set if and only if $X \cup Z$ is independent in G and $O^*(G, \kappa)$ holds.*

Note that if $\kappa(x) = 0$ for all $x \in G$ then $X = V(G)$ and $Y = \emptyset$. In this case $O^*(G, \kappa)$ vacuously holds and there is a unique Nash subgraph of (G, κ) with D -set V and empty P -set.

5 Complexity of Uniqueness of Nash Subgraph

Theorem 3. *DP -NASH SUBGRAPH UNIQUENESS is in P.*

Proof. Let (G, κ) be a weighted graph, and let $X = X(G, \kappa)$, $Y = Y(G, \kappa)$ and $Z = Z(G, \kappa)$ be as defined in the previous section. If $X \cup Z$ is not independent then there exist distinct Nash subgraphs in (G, κ) by Lemma 2. So we may assume that $X \cup Z$ is independent. By Lemma 2 there exists a Nash subgraph $(D, P; E')$ in G where $D = X \cup Z$ and $P = Y$.

If $Z \neq \emptyset$, then let $z \in Z$ be arbitrary. In E' we may pick any $\kappa(z)$ edges out of z , as every vertex in Y has an edge to X in E' . As $d(z) > \kappa(z)$ we note that by picking different edges incident with z we get distinct Nash subgraphs of G . We may therefore assume that $Z = \emptyset$.

Recall the definition of G^{aux} , which has partite sets $R' = X$ and $Y' = Y^\kappa$ (as $Z = \emptyset$).

We will now prove the following two claims which complete the proof of the theorem since the existence of a matching in $G^{\text{aux}} - x$ saturating its partite set Y' can be decided in polynomial time for every $x \in X$.

Claim A: *If for every $x \in X$ there exists a matching in $G^{\text{aux}} - x$ saturating Y' then there is only one Nash subgraph in G .*

Proof of Claim A: We will first show that if the statement of Claim A holds then $O^*(G, \kappa)$ holds. Suppose that $O^*(G, \kappa)$ does not hold. This implies that there is a set $\emptyset \neq W \subseteq Y^{\kappa > 0}$ such that $|L(W)| \leq |W^\kappa|$. Note that, as $Z = \emptyset$, we have $L(W) = N_G(W) \cap X$. As $W \neq \emptyset$ and $W \subseteq Y$, we have that $N_G(W) \cap X \neq \emptyset$. Let $x \in N_G(W) \cap X$ be arbitrary. Now the following holds.

$$|(N_G(W) \cap X) \setminus \{x\}| = |L(W)| - 1 \leq |W^\kappa| - 1 < |W^\kappa|$$

This implies that there cannot be a matching in $G^{\text{aux}} - x$ saturating Y' , a contradiction. Thus, $O^*(G, \kappa)$ must hold. By Corollary 1 we have that all Nash subgraphs must therefore have the same D -set. By Lemma 2 we have that all Nash subgraphs $(D, P; E')$ must therefore have $D = X$ and $P = Y$. By the definition of X we note that E' must contain exactly the edges between X and Y , and therefore there is a unique Nash subgraph in G . \diamond

Claim B: *If for some $x \in X$ there is no matching in $G^{\text{aux}} - x$ saturating Y' , then there are at least two distinct Nash subgraphs in G .*

Proof of Claim B: Let $x \in X$ be defined as in the statement of Claim B. By Hall's Theorem there exists a set $S' \subseteq Y'$ such that $|N_{G^{\text{aux}}}(S') \setminus \{x\}| < |S'|$. Let $S \subseteq Y$ be the set of vertices for which there is a copy in S' . Note that $(N_G(S) \cap X) \setminus \{x\} = N_{G^{\text{aux}}}(S') \setminus \{x\}$ and $|S'| \leq |S^\kappa|$, which implies the following.

$$\begin{aligned} |N_G(S) \cap X| &\leq |(N_G(S) \cap X) \setminus \{x\}| + 1 = |N_{G^{\text{aux}}}(S') \setminus \{x\}| + 1 \\ &< |S'| + 1 \leq |S^\kappa| + 1. \end{aligned}$$

As all terms above are integers, this implies that $|N_G(S) \cap X| \leq |S^\kappa|$. As $L(S) = N_G(S) \cap X$ by the definition of $L(S)$, we note that $|L(S)| \leq |S^\kappa|$ and therefore $O^*(G, \kappa)$ does not hold, which by Corollary 1 implies that there are distinct Nash subgraphs in G (even with distinct D -sets). This completes the proof of Claim B and therefore also of the theorem. \square

6 Complexity of Uniqueness of D -set

If $Z = \emptyset$ then G has a unique D -set if and only if D has a unique Nash subgraph (this follows from the proof of Theorem 3). Thus, if $Z = \emptyset$ then by Theorem 3 it is polynomial to decide whether G has a unique D -set.

However, as we can see below, in general, it is co-NP-complete to decide whether a weighted graph (G, κ) has a unique D -set (the D -SET UNIQUENESS problem). To refine this result, we consider the case when $\kappa(v) = k$ for every $v \in V(G)$. We observed in Section 1 that if $k = 0$ then $V(G)$ is the only D -set in G . The next theorem shows that D -SET UNIQUENESS remains in P when

$k = 1$. However, Theorem 5 shows that for $k \geq 2$, D -SET UNIQUENESS is co-NP-complete.

Theorem 4. *Let (G, κ) be a weighted graph and let $\kappa(x) = 1$ for all $x \in V(G)$. Let $X = \{x \mid d_G(x) = 1\}$, $Y = N(X)$ and $Z = V(G) \setminus (X \cup Y)$. Then all DP -Nash subgraphs have the same D -set if and only if $X \cup Z$ is independent and $|N_G(y) \cap X| \geq 2$ for all $y \in Y$. In particular, D -SET UNIQUENESS is in P in this case.*

Proof. If $X \cup Z$ is not independent then we are done by Lemma 2, so assume that $X \cup Z$ is independent. By Lemma 2, there exists a DP -Nash subgraph, $(D, P; E')$, such that $Y = P$. If $|N_G(y) \cap X| < 2$ for some $y \in Y$, then by Lemma 1 there exists a DP -Nash subgraph, $(D', P'; E'')$, of G , where $y \in D'$. This implies that there exists DP -Nash subgraphs where y belongs to its D -set and where y belongs to its P -set, as desired.

We now assume that $X \cup Z$ is independent and $|N_G(y) \cap X| \geq 2$ for all $y \in Y$. We will prove that all DP -Nash subgraphs have the same D -set in (G, κ) and we will do this by proving that $O^*(G, \kappa)$ holds, which by Corollary 1 implies the desired result.

Recall that $O^*(G, \kappa)$ holds if for every set $\emptyset \neq W \subseteq Y$ we have $|L(W)| > |W|$ (as $Y^{\kappa > 0} = Y$ and $W^\kappa = W$). Let W be arbitrary such that $\emptyset \neq W \subseteq Y$. By the definition of $L(W)$, we have that $|L(W)| \geq |N(W) \cap X|$. As no vertex in X has edges to more than one vertex in Y (as $d_G(x) = 1$) we have that $|N(W) \cap X| = \sum_{w \in W} |N(w) \cap X| \geq 2|W|$. Therefore, we have

$$|L(W)| \geq |N(W) \cap X| \geq 2|W| > |W|.$$

implying that $O^*(G, \kappa)$ holds, as desired. \square

The following result is proved by reductions from 3-SAT. This reduction is direct for the case of $k = 2$, where for an instance I of 3-SAT formula, we can construct a weighted graph (G, κ) such that $\kappa(x) = 2$ for every vertex x of G and (G, κ) at least two D -sets if and only if I is satisfiable. In the case of $k \geq 3$, we first trivially reduce from 3-SAT to k -OUT-OF- $(k + 2)$ -SAT, where a CNF formula F has $k + 2$ literals in every clause and F is satisfied if and only if there is a truth assignment which satisfies at least k literals in every clause. Then we reduce from k -OUT-OF- $(k + 2)$ -SAT to the complement of D -SET UNIQUENESS. While the main proof structure is similar in both cases, the constructions of (G, κ) are different. The full proof can be found in Appendix B.

Theorem 5. *Let $k \geq 2$ be an integer. D -SET UNIQUENESS is co-NP-complete for weighted graphs (G, κ) with $\kappa(x) = k$ for all $x \in V(G)$.*

7 Conclusions

We have proved that UNIQUENESS D -SET is co-NP-complete. It is not hard to solve this problem in time $\mathcal{O}^*(2^n)$, where \mathcal{O}^* hides not only coefficients, but also

polynomials in n . Indeed, we can consider every non-empty subset S of $V(G)$ in turn and check whether S is the D -set of a Nash subgraph of (G, κ) using network flows. Conditional on the Strong Exponential Time Hypothesis holding, one can show that there exists a $\delta > 0$ such that UNIQUENESS D -SET cannot be solved in time- $\mathcal{O}^*(2^{n^\delta})$. A natural open question is to compute a maximum such value δ .

Consider a weighted graph (K_{3n}, κ) , where $n \geq 1$ and $\kappa(v) = 2$ for every $v \in V(K_{3n})$. Observe that every p -size subset of $V(K_{3n})$ for $n \leq p \leq 3n - 2$ is a D -set. Thus, a weighted graph can have an exponential number of D -sets and hence of Nash subgraphs. This leads to the following open questions: (a) What is the complexity of counting all Nash subgraphs of a weighted graph? (b) Is there an $\mathcal{O}^*(\text{dp}(G, \kappa))$ -time algorithm to generate all Nash subgraphs of (G, κ) , where $\text{dp}(G, \kappa)$ is the number of Nash subgraphs in (G, κ) ?

References

1. Bramoullé, Y., Kranton, R.: Public goods in networks. *Journal of Economic Theory* **135**(1), 478–494 (2007)
2. Corneil, D., Perl, Y.: Clustering and domination in perfect graphs. *Discrete Appl. Math.* **9**, 27–39 (1984)
3. Cygan, M., Pilipczuk, M., Wojtaszczyk, J.O.: Capacitated domination faster than $\mathcal{O}(2^n)$. *Inf. Process. Lett.* **111**(23-24), 1099–1103 (2011)
4. Gale, D., Shapley, L.S.: College admissions and the stability of marriage. *The American Mathematical Monthly* **69**(1), 9–15 (1962)
5. Galeotti, A., Goyal, S., Jackson, M.O., Vega-Redondo, F., Yariv, L.: Network games. *The Review of Economic Studies* **77**(1), 218–244 (2010)
6. Gerke, S., Gutin, G., Hwang, S.H., Neary, P.R.: Netflix games: Local public goods with capacity constraints. arXiv:1905.01693 (2019)
7. Goddard, W., Henning, M.A.: Independent domination in graphs: A survey and recent results. *Discrete Mathematics* **313**(7), 839–854 (2013)
8. Gutin, G., Hirano, T., Hwang, S.H., Neary, P.R., Toda, A.A.: The effect of social distancing on the reach of an epidemic in social networks. arXiv:2005.03067 (2020)
9. Kao, M., Chen, H., Lee, D.: Capacitated domination: Problem complexity and approximation algorithms. *Algorithmica* **72**(1), 1–43 (2015)
10. Kermack, W.O., McKendrick, A.G.: A contribution to the mathematical theory of epidemics. *Proceedings of the Royal Society of London. Series A, Containing Papers of a Mathematical and Physical Character* **115**(772), 700–721 (1927), <http://www.jstor.org/stable/94815>
11. Morris, S., Shin, H.S.: Unique equilibrium in a model of self-fulfilling currency attacks. *The American Economic Review* **88**(3), pp. 587–597 (1998)
12. Nash, J.: Non-cooperative games. *The Annals of Mathematics* **54**(2), 286–295 (September 1951)
13. Nash, J.F.: Equilibrium points in n -person games. *Proceedings of the National Academy of Sciences of the United States of America* **36**(1), 48–49 (1950)
14. Roth, A.E.: Deferred acceptance algorithms: history, theory, practice, and open questions. *International Journal of Game Theory* **36**(3), 537–569 (2008)

Appendix A: Proof of Theorem 1

The proof is a slight modification of the proof in [6].

Recall that by Assumption 1, for all $v \in V$ we have $\kappa(v) \leq d(v)$. The proof proceeds by induction on the number n of vertices of G . If $n = 1$, then G is a Nash subgraph with $D = V(G)$ and $P = \emptyset$. Now assume the claim is true for all graphs with fewer than $n \geq 2$ vertices, and let G be a graph on n vertices.

Case 1: There is a vertex u of degree equal $\kappa(u)$. Let B be the star with center $\{u\}$ and leaves $N_G(u)$ and let $G' = G - B$. If G' has no vertices then B is clearly a Nash subgraph of G with D -set $\{u\}$ and P -set $N_G(u)$. Otherwise, by induction hypothesis, G' has a Nash subgraph $H' = (D', P'; E)$. Construct a subgraph H of G from the disjoint union of H' and B as follows. For every $v \in D'$ with $d_{G'}(v) < \kappa(v)$, add exactly $\kappa(v) - d_{G'}(v)$ edges of G between v and $N_G(u)$. Set $D = D' \cup \{u\}$ and $P = P' \cup N(u)$. To see that H is a Nash subgraph of G , observe that (a) H is a spanning bipartite subgraph of G as H' and B are bipartite and the added edges are between D and P only, (b) every vertex $x \in D$ has degree in H equal to $\kappa(x)$, and (c) every vertex $y \in P$ is of positive degree (since it is so in both B and H').

Case 2: For every vertex $z \in V(G)$, $d_G(z) > \kappa(z)$. Let u be an arbitrary vertex. Delete any $d_G(u) - \kappa(u)$ edges incident to u and denote the resulting graph by L . Observe that every Nash subgraph of L is a Nash subgraph of G since no vertex in L has degree less than $\kappa(u)$. This reduces Case 2 to Case 1. \square

Appendix B: Proof of Theorem 5

Case 1: $k = 2$. We will reduce from 3-SAT. Let $I = C_1 \wedge C_2 \wedge \dots \wedge C_m$ be an instance of 3-SAT. Let v_1, v_2, \dots, v_n be the variables in I . Assume without loss of generality that n is even (otherwise, we add to I a new clause which contains three new variables). We will now build a graph G and let $\kappa(x) = 2$ for every vertex x of G , such that there exist DP -Nash subgraphs of G with distinct D -sets if and only if I is satisfiable.

First define G_1 as follows. Let $W_i = \{w_i, \bar{w}_i\}$ for all $i = 1, 2, \dots, n$. Let $V(G_1) = W_1 \cup W_2 \cup \dots \cup W_n \cup \{r_1, r_2, \dots, r_n\}$. Let $E(G_1)$ contain all edges between W_{2i-1} and W_{2i} and the edge $r_{2i}r_{2i+1}$ for $i = 1, 2, \dots, \frac{n}{2}$ (where $r_{n+1} = r_1$) and edges between r_i and W_i for $i = 1, 2, \dots, n$. The graph G_1 is illustrated below when $n = 6$.

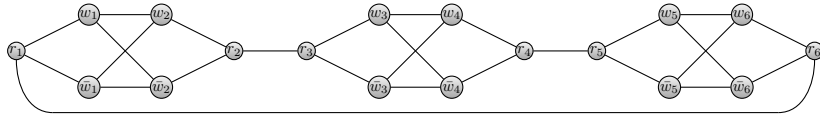

Let G_1^s be the graph obtained from G_1 after subdividing every edge once. Let $u(e)$ denote the new vertex used to subdivide the edge $e \in E(G_1)$ and let $U = \{u(e) | e \in E(G_1)\}$. The graph G_1^s is illustrated below when $n = 6$.

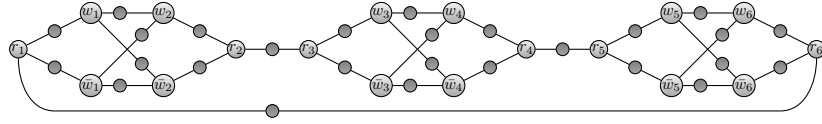

Let $Q = \{q_1, q_2\}$, let $X^* = \{x_1^*, x_2^*, x_3^*, x_4^*, x_5^*\}$, and for every $i = 1, 2, \dots, n$, let $Z_i = \{z_i^1, z_i^2, z_i^3, z_i^4, z_i^5\}$. Let G_2 be obtained from G_1^s by adding the vertices $Q \cup X^* \cup Z_1 \cup Z_2 \cup \dots \cup Z_n$. Furthermore, add all edges from W_i to Z_i , all edges from Z_i to q_1 for $i = 1, 2, \dots, n$, and all edges from Q to X^* . The graph G_2 is illustrated below when $n = 6$.

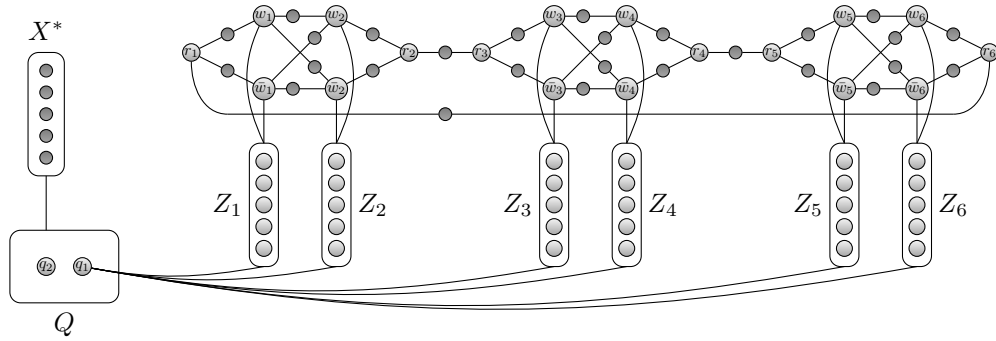

We now construct G from G_2 by adding the vertices $\{c_1, c_2, \dots, c_m\}$ and the following edge for each $j = 1, 2, \dots, m$. If the clause C_j contains the literal v_i then add an edge from c_j to w_i and if C_j contains the literal \bar{v}_i then add an edge from c_j to \bar{w}_i . Finally, add an edge from c_j to q_1 for each $j = 1, 2, \dots, m$. This completes the construction of G . If $I = (\bar{v}_2 \vee v_3 \vee v_5) \wedge \dots$ and I contains six variables then G is illustrated below.

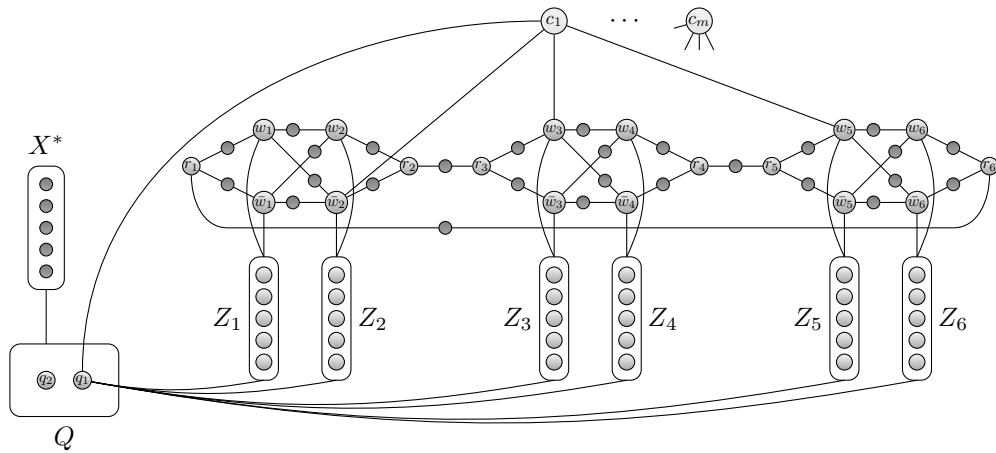

We will now show that there exist DP -Nash subgraphs of G with distinct D -sets if and only if I is satisfiable. We prove this using the following three claims.

Claim A: *There exists a DP -Nash subgraph $(D, P; E')$ of G such that $P = V(G_1) \cup Q$ and $D = V(G) \setminus P$.*

Proof of Claim A: This claim follows from Lemma 2. Indeed, $X(G, \kappa) = X^* \cup U$, $Y(G, \kappa) = Q \cup V(G_1)$ and $Z(G, \kappa) = V(G) \setminus (X(G, \kappa) \cup Y(G, \kappa))$. Observe that $X(G, \kappa) \cup Z(G, \kappa)$ is an independent set. Thus, Y is a P -set in G . \diamond

Claim B: *If I is satisfiable then there exists a DP -Nash subgraph, $(D, P; E')$, such that $P \neq V(G_1) \cup Q$.*

Proof of Claim B: Assume that I is satisfiable and let τ be a truth assignment to the variables in I which satisfies I . Construct P and D as follows. We start by constructing $P \setminus U$ and $D \setminus U$. Since $D = V(G) \setminus P$, we will describe only $P \setminus U$. For every $i = 1, 2, \dots, n$, if v_i is true in τ then add the vertex w_i to P otherwise \bar{w}_i to P . Add Q to P . This completes construction of $P \setminus U$.

We will now distribute the vertices $u(e)$ in P and D for each $e \in E(G_1)$ and construct E' such that $(D, P; E')$ is a DP -Nash subgraph of G with $P \neq V(G_1) \cup Q$. Let E' contain all edges between X^* and Q . For each $z \in Z_i$ add the edge zq_1 to E' and add the edge between z and the vertex in W_j that belongs to P to E' for $i = 1, 2, \dots, n$. For each $j = 1, 2, \dots, m$ add the edge c_jq_1 to E' and the edge from c_j to the vertex w_i if v_i is a true literal in I and to the vertex \bar{w}_i if \bar{v}_j is a true literal in I (just pick one true literal in C_j).

Initially add all $u(e)$ to P for $e \in V(G_1)$. We will move some of these vertices to D below. For each $i = 1, 2, \dots, \frac{n}{2}$ proceed as follows.

- If $w_{2i-1}, w_{2i} \in D$: Move the vertex $u(\bar{w}_{2i-1}\bar{w}_{2i})$ to D . Now add the edges shown in the below picture to E' .

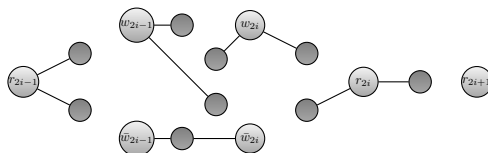

- If $w_{2i-1}, \bar{w}_{2i} \in D$: Move the vertex $u(\bar{w}_{2i-1}w_{2i})$ to D . Now add the edges shown in the below picture to E' .

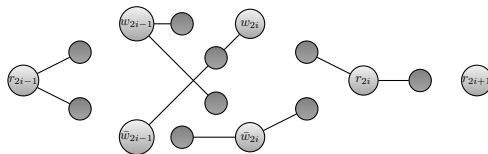

- If $\bar{w}_{2i-1}, w_{2i} \in D$: Move the vertex $u(w_{2i-1}\bar{w}_{2i})$ to D . Now add the edges shown in the below picture to E' .

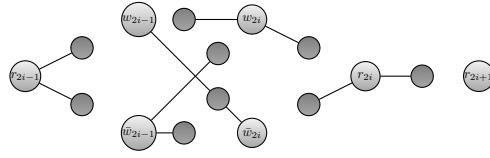

- If $\bar{w}_{2i-1}, \bar{w}_{2i} \in D$: Move the vertex $u(w_{2i-1}w_{2i})$ to D . Now add the edges shown in the below picture to E' .

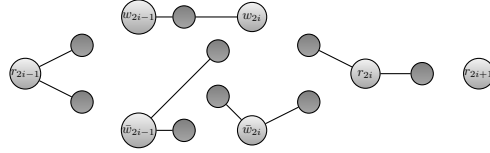

After the above process we obtain the desired DP -Nash subgraph $(D, P; E')$. \diamond

Claim C: *If there exists a DP -Nash subgraph $(D, P; E')$ such that $P \neq V(G_1) \cup Q$ then I is satisfiable.*

Proof of Claim C: Assume that there exists a DP -Nash subgraph $(D, P; E')$ of G such that $P \neq V(G_1) \cup Q$. We now show the following subclaims which complete the proof of Claim C and therefore of Case 1.

Subclaim C.1: $X^* \subseteq D$ and $Q \subseteq P$.

Proof of Subclaim C.1: Suppose that $Q \not\subseteq P$. This implies that each vertex in X^* has at most one neighbour in P and therefore $X^* \subseteq P$. However, then each vertex in X^* has an edge to D in E' , but these five edges are all incident with $\{q_1, q_2\}$, a contradiction to $\kappa(q_1) = \kappa(q_2) = 2$. Therefore, $Q \subseteq P$. This immediately implies that $X^* \subseteq D$, as if some $x \in X^*$ belonged to P then it would have no edge to D in E' . \diamond

Subclaim C.2: $|D \cap W_i| \leq 1$ for all $i = 1, 2, 3, \dots, n$.

Proof of Subclaim C.2: Suppose that $|D \cap W_i| > 1$ for some $i \in \{1, 2, \dots, n\}$. This implies that $\{w_i, \bar{w}_i\} \subseteq D$. In this case we must have $Z_i \subseteq P$ as every $z \in Z_i$ has exactly one neighbour in P (namely q_1). By Subclaim C.1 we note that $q_1 \in P$, which implies that every vertex in Z_i has an edge into D in E' and all these five edges must be incident with W_i . This is a contradiction to $\kappa(w_i) = \kappa(\bar{w}_i) = 2$ and thus to $|D \cap W_i| > 1$. \diamond

Subclaim C.3: $|D \cap W_i| = 1$ for all $i = 1, 2, 3, \dots, n$ and $c_j \in D$ for all $j = 1, 2, \dots, m$

Proof of Subclaim C.3: Let $D' = D \cap V(G_1)$. If $D' = \emptyset$, then we note that $u(e) \in D$ for every $e \in E(G_1)$, $c_j \in D$ for every $j = 1, 2, \dots, m$, and $Z_i \subseteq D$ for every $i = 1, 2, \dots, n$, by Subclaim C.1. By Subclaim C.1 we note that $P = V(G_1) \cup Q$, a contradiction to our assumption in the beginning of the proof of Claim C. Therefore $D' \neq \emptyset$.

Let G' be the subgraph of G_1 induced by the vertices in D' . By Subclaim C.2 we note that the maximum degree $\Delta(G')$ of G' is at most 2, as G_1 is 3-regular and every vertex in G_1 is adjacent to both vertices in W_j for some j . This implies that $|E(G')| \leq |V(G')| = |D'|$. Let $C_P = P \cap \{c_1, c_2, \dots, c_m\}$.

Suppose that $|E(G')| < |D'| + |C_P|$. Let E'' denote all edges in G_1 that are incident with at least one vertex from D' . As G_1 is 3-regular we note that the following holds.

$$|E''| = 3|D'| - |E(G')| > 3|D'| - (|D'| + |C_P|) = 2|D'| - |C_P|$$

However, we note that $u(e) \in P$ for every $e \in E''$ (as it has degree two in G and a neighbour in D). These $|E''|$ edges as well as the $|C_P|$ edges from C_P to D in E' are all incident with D' in E' , a contradiction to $|E''| + |C_P| > 2|D'|$ (as $\kappa(s) = 2$ for all vertices $s \in V(G)$). Therefore $|E(G')| \geq |D'| + |C_P|$. As $|E(G')| \leq |D'|$ this implies that $|E(G')| = |D'|$ and $|C_P| = 0$.

As $\Delta(G') \leq 2$ this implies that G' is a collection of cycles (that is, 2-regular). By Subclaim C.2 we note that the only possible cycle in G' is the cycle of length $2n$ containing all r_1, r_2, \dots, r_n and exactly one vertex from each set W_i . Therefore D' contains exactly one vertex from each W_i for $i = 1, 2, \dots, n$, as desired. As $|C_P| = 0$ we also note that $c_j \in D$ for all $j = 1, 2, \dots, m$. \diamond

Subclaim C.4: *I is satisfiable if we let v_i be true when $w_i \in P$ and let v_i be false when $w_i \in D$ for all $i = 1, 2, \dots, n$.*

Proof of Subclaim C.4: For each $j = 1, 2, \dots, m$ proceed as follows. By Subclaim C.3 we note that $c_j \in D$ and therefore has two edges to P in E' . At least one of these edges must go to a vertex in $V(G_1)$ as c_j is only incident with one edge that is not incident with $V(G_1)$ (namely $c_j q_1$). If $c_j w_i \in E'$ then $w_i \in P$ and v_i is true and v_i is a literal of C_j , so C_j is satisfied. Alternatively if $c_j \bar{w}_i \in E'$ then $\bar{w}_i \in P$ (as $w_i \in D$ and Subclaim C.3) and v_i is false and \bar{v}_i is a literal of C_j , so again C_j is satisfied. This implies that C_j is satisfied for all $j = 1, 2, \dots, m$, which completes the proof of Case 1.

Case 2: $k \geq 3$. We will reduce from k -OUT-OF- $(k + 2)$ -SAT. That is, every clause will contain $k + 2$ literals, and we need to satisfy at least k of the literals for the clause to be satisfied. This problem is NP-complete, as we can reduce an instance of 3-SAT to an instance of this problem by adding $k - 1$ dummy variables, $v'_1, v'_2, \dots, v'_{k-1}$ and adding these as literals to every clause.

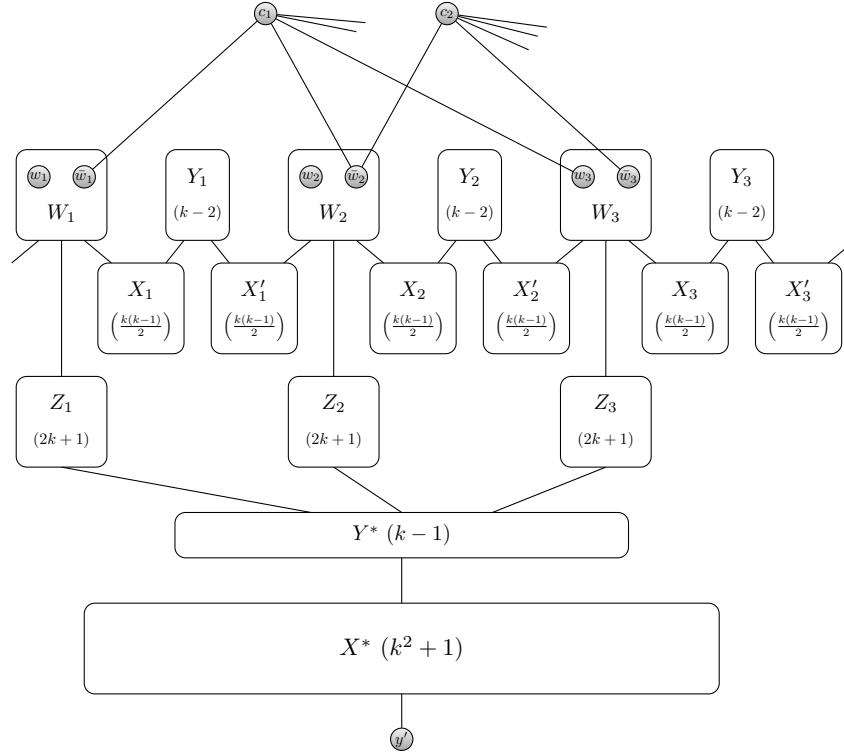

Let $I = C_1 \wedge C_2 \wedge \dots \wedge C_m$ be an instance of k -OUT-OF- $(k+2)$ -SAT where each clause C_i contains $k+2$ literals. Let v_1, v_2, \dots, v_n be the variables in I . We will now build a graph G , where $\kappa(x) = k$ for every vertex x of G . For each $i = 1, 2, 3, \dots, n$, let $W_i = \{w_i, \bar{w}_i\}$, let X_i and X'_i be vertex sets of size $\frac{k(k-1)}{2}$, let Y_i be a vertex set of size $k-2$, and let Z_i a vertex set of size $2k+1$. Furthermore, let X^* be a vertex set of size k^2+1 , let Y^* be a vertex set of size $k-1$, and $C = \{c_1, c_2, \dots, c_m\}$. Let y' be a vertex and define a graph G as follows (see the illustration above).

$$V(G) = \{y'\} \cup Y^* \cup X^* \cup C \cup (\cup_{i=1}^n (W_i \cup X_i \cup X'_i \cup Y_i \cup Z_i))$$

We first add the following edges to G for all $i = 1, 2, \dots, n$ (where subscript $n+1$ is equivalent to 1): All edges from Y^* to Z_i , from Z_i to W_i , from W_i to X_i , from X_i to Y_i , from Y_i to X'_i , and from X'_i to W_{i+1} . Furthermore, add all edges from y' to X^* and all edges from X^* to Y^* . We then for all $j = 1, 2, \dots, m$ add edges from c_j to the vertices corresponding to the literals in the clause. (In the figure above, C_1 contains literals $\bar{v}_1, \bar{v}_2, v_3, \dots$ and C_2 contains literals $\bar{v}_2, \bar{v}_3, \dots$)

Recall that $\kappa(v) = k$ for all $v \in V(G)$. Define X , Y and Z as follows.

$$\text{Let } X = X^* \cup (\cup_{i=1}^n (X_i \cup X'_i)).$$

$$\text{Let } Y = N(X) - X = \{y'\} \cup Y^* \cup (\cup_{i=1}^n (W_i \cup Y_i)).$$

$$\text{Let } Z = V(G) \setminus (X \cup Y) = C \cup (\cup_{i=1}^n Z_i).$$

We will now show that there exist Nash subgraphs of G with at least two distinct D -sets if and only if I is satisfiable. We prove this using the following claims.

Claim A: *There exists a Nash subgraph $(D, P; E')$ of G such that $P = Y$ and $D = X \cup Z$.*

Proof of Claim A: This claim follows from Lemma 2. Indeed, $X(G, \kappa) = X$, $Y(G, \kappa) = Y$ and $Z(G, \kappa) = Z$. Observe that $X \cup Z$ is an independent set. Thus, Y is a P -set in G .

Claim B: *If I is satisfiable then there exists a Nash subgraph $(D, P; E')$ such that $P \neq Y$.*

Proof of Claim B: Assume that I is satisfiable and let τ be a truth assignment to the variables in I which satisfies I . Construct P and D as follows.

- If $\tau(v_i) = \text{true}$ then let $w_i \in P$ and $\bar{w}_i \in D$.
- If $\tau(v_i) = \text{false}$ then let $\bar{w}_i \in P$ and $w_i \in D$.
- Let $X_i \cup X'_i$ belong to P for all $i = 1, 2, \dots, n$.
- Let $Z_i \cup Y_i$ belong to D for all $i = 1, 2, \dots, n$.

Let $\{y'\} \cup Y^*$ belong to P and $C \cup X^*$ to D . This defines P and D . We now define E' . Let E' contain all edges between X^* and $\{y'\} \cup Y^*$. For every vertex in Z_i ($i = 1, 2, \dots, n$) add an edge to the vertex in W_i that belongs to P and add all edges to Y^* . For each vertex in W_i ($i = 1, 2, \dots, n$) that belongs to D add k edges to X_i . For each $i = 1, 2, \dots, n$ add $k(k-1)/2 - k$ edges from Y_i to X_i and $k(k-1)/2$ edges from Y_i to X'_i in such a way that each of the $k-2$ vertices in Y_i is incident with k edges and each vertex in X_i and X'_i is incident with exactly one edge (from $W_i \cup Y_i$). Finally, for each $j = 1, 2, \dots, m$ pick k true literals in C_j and add an edge from c_j to w_i if v_i is one of the true literals and add an edge from c_j to \bar{w}_i if \bar{v}_i is a true literal. This completes the construction of E' . We note that $(D, P; E')$ is a Nash subgraph with $P \neq Y$.

Claim C: *If there exists a Nash subgraph $(D, P; E')$ such that $P \neq Y$ then I is satisfiable.*

Proof of Claim C: Assume that there exists a Nash subgraph $(D, P; E')$ of G such that $P \neq Y$. We now show the following subclaims which complete the proof of Claim C and therefore of the theorem.

Subclaim C.1: $X^* \subseteq D$ and $\{y'\} \cup Y^* \subseteq P$.

Proof of Subclaim C.1: Suppose that $\{y'\} \cup Y^* \not\subseteq P$. This implies that each vertex in X^* has at most $k-1$ neighbours in P and therefore $X^* \subseteq P$. However, then each vertex in X^* has an edge to D in E' , but these $k^2 + 1$ edges are all incident with the k vertices $\{y'\} \cup Y^*$, a contradiction to $\kappa(x) = k$ for every $x \in X^*$. Therefore, $\{y'\} \cup Y^* \subseteq P$. This immediately implies that $X^* \subseteq D$, as if some $x \in X^*$ belonged to P then it would have no edge to D in E' . \diamond

Subclaim C.2: $|D \cap W_i| \leq 1$ for all $i = 1, 2, 3, \dots, n$.

Proof of Subclaim C.2: Suppose that $|D \cap W_i| > 1$ for some $i \in \{1, 2, \dots, n\}$. This implies that $\{w_i, \bar{w}_i\} \subseteq D$. In this case we must have $Z_i \subseteq P$ as every $z \in Z_i$

has at most $k - 1$ neighbours in P (namely the vertices in Y^*). By Subclaim C.1 we note that $Y^* \subseteq P$, which implies that every vertex in Z_i has an edge into D in E' and all these $2k + 1$ edges must be incident with W_i . This is a contradiction to $\kappa(w_i) = \kappa(\bar{w}_i) = k$ and thus to $|D \cap W_i| > 1$. \diamond

Subclaim C.3: $|D \cap W_i| = 1$ for all $i = 1, 2, \dots, n$ and $c_j \in D$ for all $j = 1, 2, \dots, m$

Proof of Subclaim C.3: By Subclaim C.2 we note that $|D \cap W_i| \leq 1$. Suppose that $|D \cap W_i| = 0$ for some $i \in \{1, 2, \dots, n\}$. We consider the following two cases.

Case C.3.1: $|D \cap W_i| = 0$ for all $i = 1, 2, \dots, n$. If $D \cap Y_i \neq \emptyset$ for some i , then $X_i \cup X'_i \subseteq P$, as every vertex, x , in this set has $d_G(x) = \kappa(x) = k$ and at least one neighbour is in D . However the $k(k - 1)$ vertices in $X_i \cup X'_i$ will all have edges into $D \cap Y_i$ (as $|D \cap W_i| = 0$ for all $i = 1, 2, \dots, n$) in E' , a contradiction to $D \cap Y_i$ being incident with at most $k|Y_i| = k(k - 2)$ edges. Therefore we may assume that $D \cap Y_i = \emptyset$ for all $i = 1, 2, \dots, n$.

By Subclaim C.1 we note that $Y = \{y'\} \cup Y^* \cup (\cup_{i=1}^n (W_i \cup Y_i)) \subseteq P$. In this case we must have $Y = P$, as $G - Y$ is independent. This is a contradiction to $P \neq Y$. This completes Case C.3.1.

Case C.3.2: $|D \cap W_i| \neq 0$ for some $i \in \{1, 2, \dots, n\}$. Without loss of generality assume that $|D \cap W_1| \neq 0$. This implies that $X_1 \cup X_n \subseteq P$, as every vertex, $x \in X_1 \cup X_n$, has $d_G(x) = \kappa(x) = k$ and at least one neighbour is in D . Without loss of generality assume that the vertex in $D \cap W_1$ has at least as many edges to X_n as to X_1 in E' . This implies that there are at most $k/2$ edges from $D \cap W_1$ to X_1 in E' . As $k/2 < k(k - 1)/2$ we note that $Y_1 \cap D \neq \emptyset$. This implies that $X'_1 \subseteq P$, as every vertex, $x \in X'_1$, has $d_G(x) = \kappa(x) = k$ and at least one neighbour is in D . As $X_1 \cup X'_1 \subseteq P$, $X_1 \cup X'_1$ has at least $|X_1| + |X'_1| = k(k - 1)$ edges into $D \cap (W_1 \cup Y_1 \cup W_2)$. This implies that $W_2 \cap D \neq \emptyset$, as there can be at most $k/2 + k(k - 2)$ edges from $D \cap (W_1 \cup Y_1)$ to $X_1 \cup X'_1$ in E' . Furthermore there are at least $k/2$ edges from $D \cap W_2$ to X'_1 in E' . Continuing the above process we note that $W_3 \cap D \neq \emptyset$, $W_4 \cap D \neq \emptyset$, etc. This contradicts the fact that $|D \cap W_i| = 0$ for some i . This completes Case C.3.2.

By the above two cases we note that $|D \cap W_i| = 1$ for all $i = 1, 2, \dots, n$. This implies that $X_i \cup X'_i \subseteq P$ for all $i = 1, 2, \dots, n$. Therefore there are at least $nk(k - 1)$ edges from $\cup_{i=1}^n (X_i \cup X'_i)$ to $D \cap (\cup_{i=1}^n (W_i \cup Y_i))$. As $|D \cap W_i| = 1$ for all $i = 1, 2, \dots, n$ there can be at most $nk + nk(k - 2)$ such edges. This implies that there are exactly $nk(k - 1)$ edges from $\cup_{i=1}^n (X_i \cup X'_i)$ to $D \cap (\cup_{i=1}^n (W_i \cup Y_i))$ and there are no edges from $D \cap (\cup_{i=1}^n (W_i \cup Y_i))$ to any vertex in P that does not lie in $\cup_{i=1}^n (X_i \cup X'_i)$. This implies that $c_j \in D$ for all $j = 1, 2, \dots, m$, as if some $c_j \in P$ then it would not have any edge to D . \diamond

Subclaim C.4: I is satisfiable if we let v_i be true when $w_i \in P$ and let v_i be false when $w_i \in D$ for all $i = 1, 2, \dots, n$.

Proof of Subclaim C.4: For each $j = 1, 2, \dots, m$ proceed as follows. By Subclaim C.3 we note that $c_j \in D$ and therefore has k edges to P in E' . If $c_j w_i \in E'$ then $w_i \in P$ and v_i is true and v_i is a literal of C_j which is satisfied. Alternatively if $c_j \bar{w}_i \in E'$ then $\bar{w}_i \in P$ (as $w_i \in D$ and Subclaim C.3) and v_i is false

and \bar{v}_i is a literal of C_j which again is satisfied. As there are k edges from c_j to P in E' we obtain k true literals in C_j , which implies that C_j is satisfied for all $j = 1, 2, \dots, m$, which completes the proof of the theorem. \square